

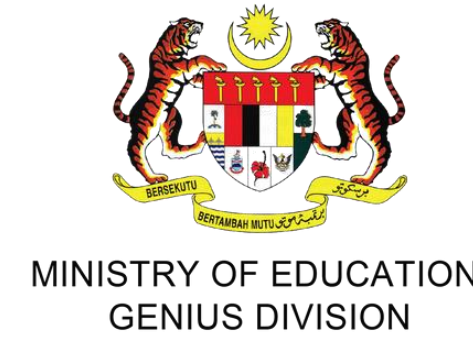

NARATIF BAHARU UKM
UNIVERSITI ATAN KITA



Masterplan

GENIUS@Pintar NATIONAL GIFTED CENTER NATIONAL UNIVERSITY OF MALAYSIA

| LEGEND | |
|--------|-------------------------|
| A | ADMINISTRATION BLOCK |
| LA | LABORATORY BLOCK A |
| LB | LABORATORY BLOCK B |
| CA | CLASSROOM BLOCK A |
| CB | CLASSROOM BLOCK B |
| AB | ACADEMICIAN BLOCK |
| HA | HOSTEL BLOCK A (FEMALE) |
| HB | HOSTEL BLOCK B (FEMALE) |
| HC | HOSTEL BLOCK C (MALE) |
| HD | HOSTEL BLOCK D (MALE) |
| CF | CAFETERIA |
| MH | MULTI-PURPOSE HALL |
| DH | DINING HALL |
| AD | AUDITORIUM |
| SP | SWIMMING POOL |
| SG | SPORTS GROUND |
| G | GUARD HOUSE |
| R | REFUSE CHAMBER |



GMUN 2023

GENIUS MODEL UNITED NATIONS CONFERENCE

7-9
JULY
2023 | BEYOND BORDERS:
BRIDGING THE DIVIDE

Pusat GENIUS@Pintar Negara, Universiti Kebangsaan Malaysia

Masterplan

CLASSROOM BLOCK

GENIUS@Pintar NATIONAL GIFTED CENTER

NATIONAL UNIVERSITY OF MALAYSIA

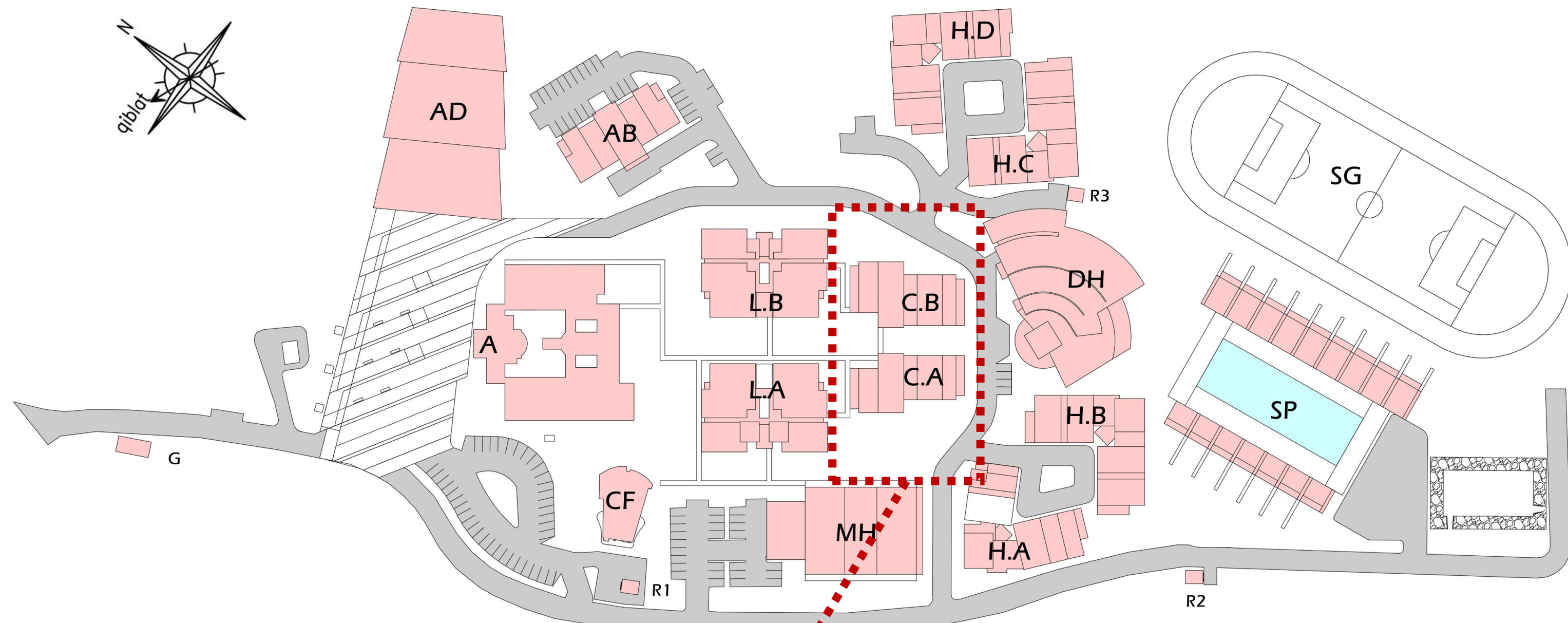

| LEGEND | | | | |
|--------|---------------|-------|----------|---------|
| BLOCK | | SPACE | | COUNCIL |
| C.A | CLASS BLOCK A | C1 | Class 1 | IPC |
| C.B | CLASS BLOCK B | C1 | Class 1 | ECOSOC |
| | | C2 | Class 2 | |
| | | C3 | Class 3 | |
| | | C4 | Class 4 | DISEC |
| | | C5 | Class 5 | |
| | | C6 | Class 6 | UNHRC |
| | | C7 | Class 7 | |
| | | C8 | Class 8 | UNESCO |
| | | C9 | Class 9 | |
| | | C10 | Class 10 | UNEP |
| | | C11 | Class 11 | |
| | | C12 | Class 12 | UNWOMEN |

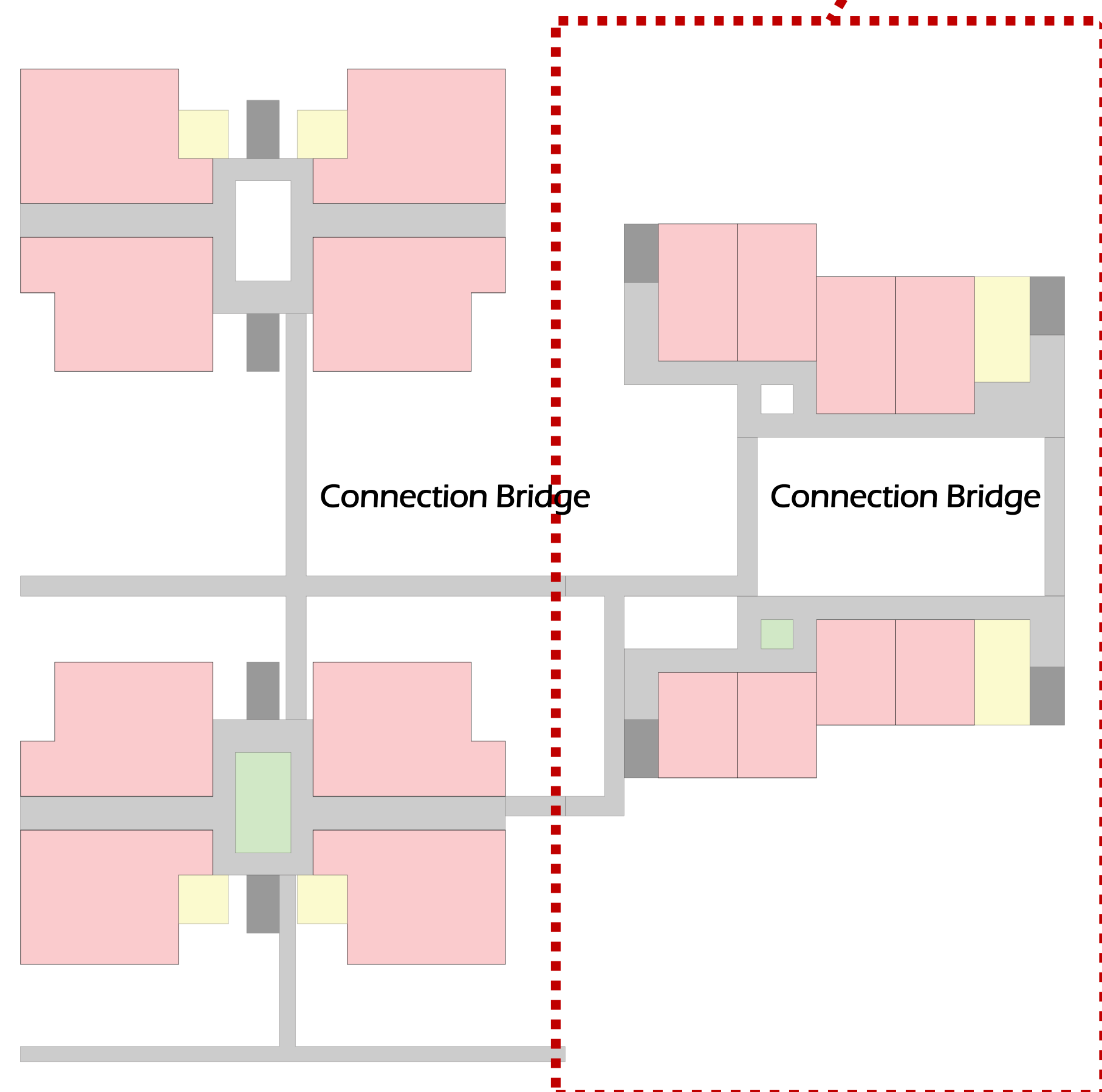

CLASS BLOCK B

CLASS BLOCK A

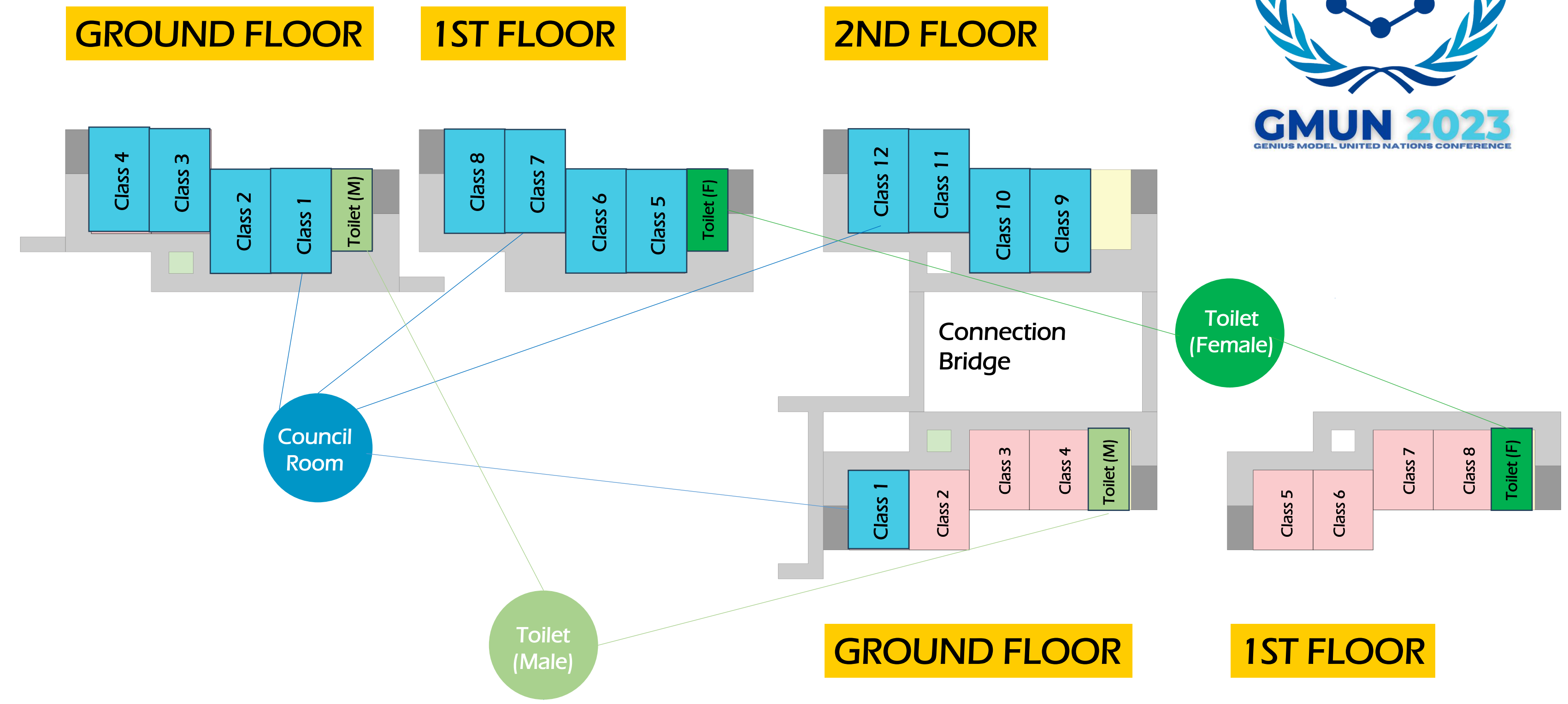



GMUN 2023
GENIUS MODEL UNITED NATIONS CONFERENCE

Masterplan **LABORATORY BLOCK** GENIUS@Pintar NATIONAL GIFTED CENTER NATIONAL UNIVERSITY OF MALAYSIA

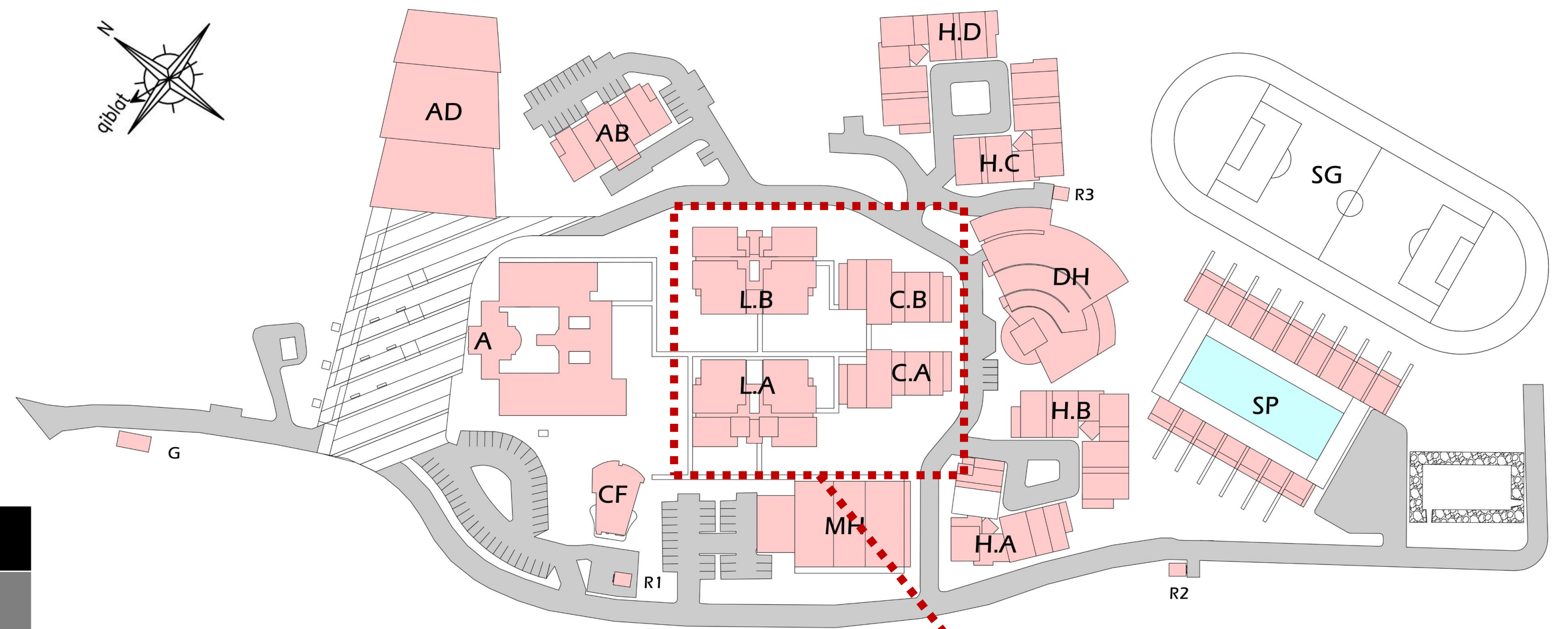

| LEGEND | | |
|--------|--------------------|---------|
| BLOCK | SPACE | COUNCIL |
| L.B | LABORATORY BLOCK B | LL.2 |
| | Language Lab 2 | CRISIS |

GROUND FLOOR

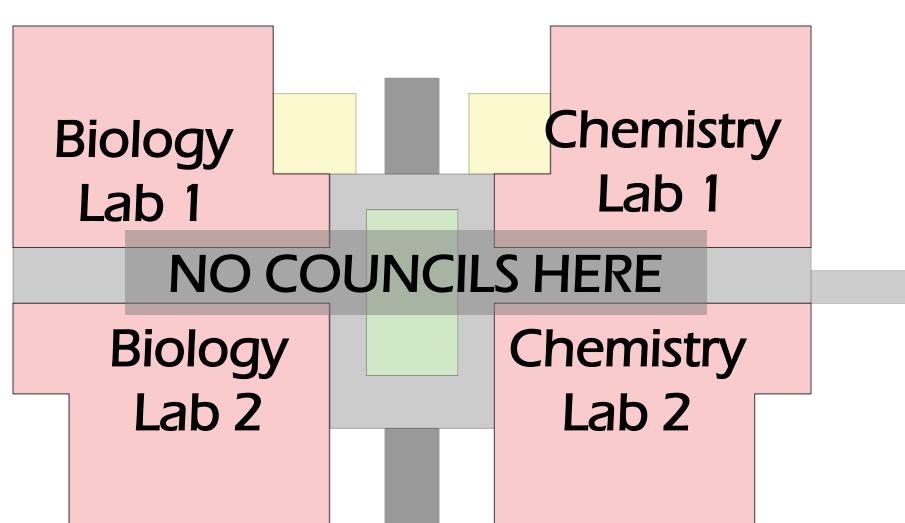

1ST FLOOR

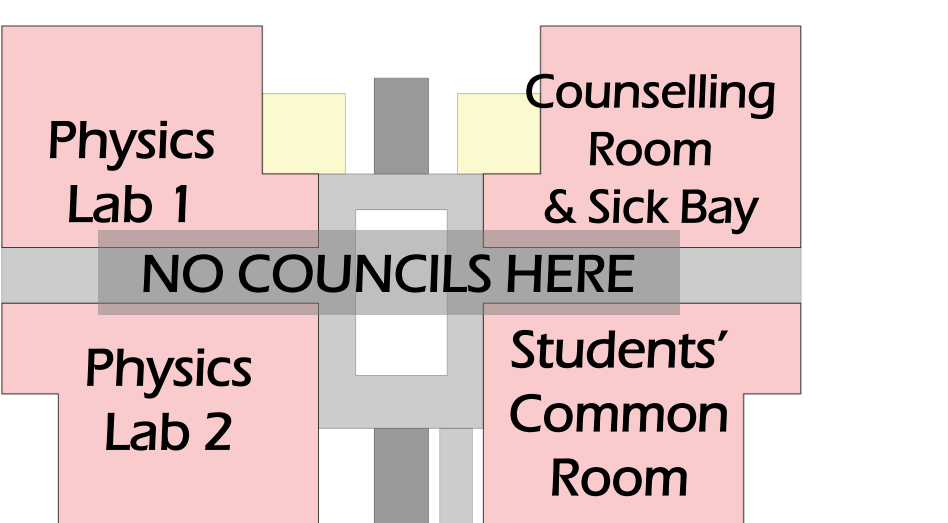

2ND FLOOR

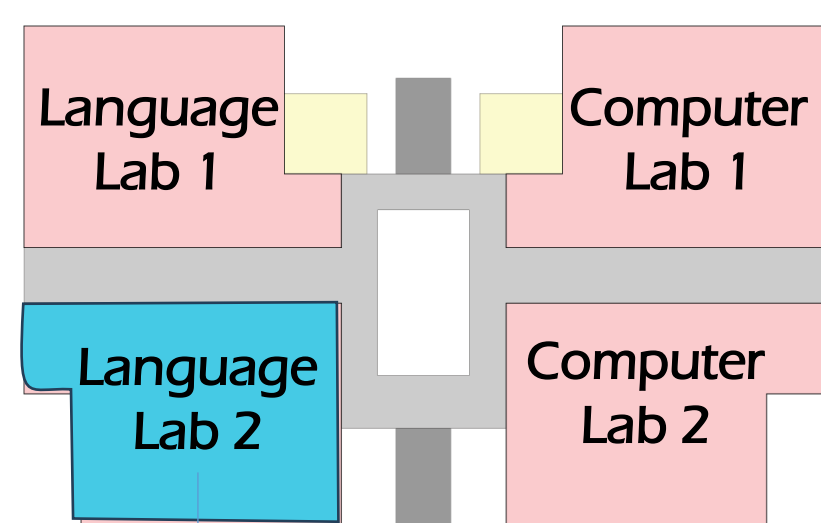

3RD FLOOR



LABORATORY BLOCK B

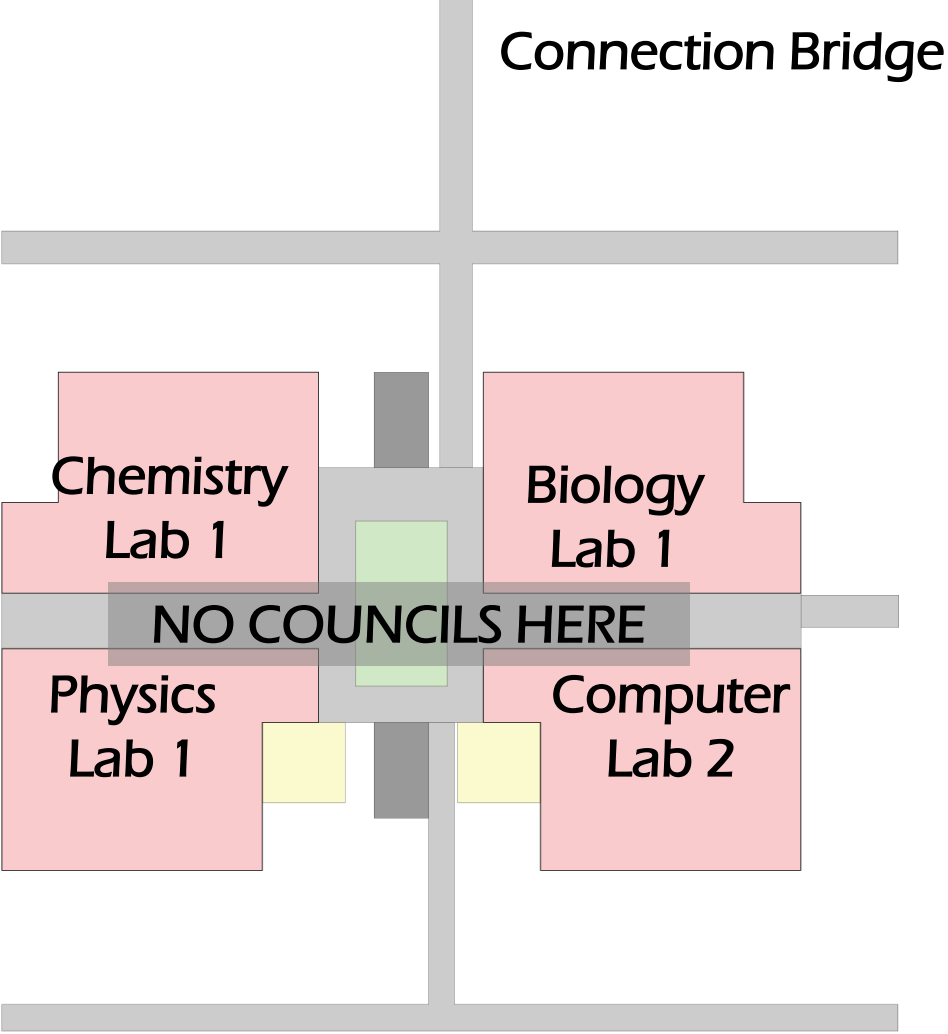

GROUND FLOOR

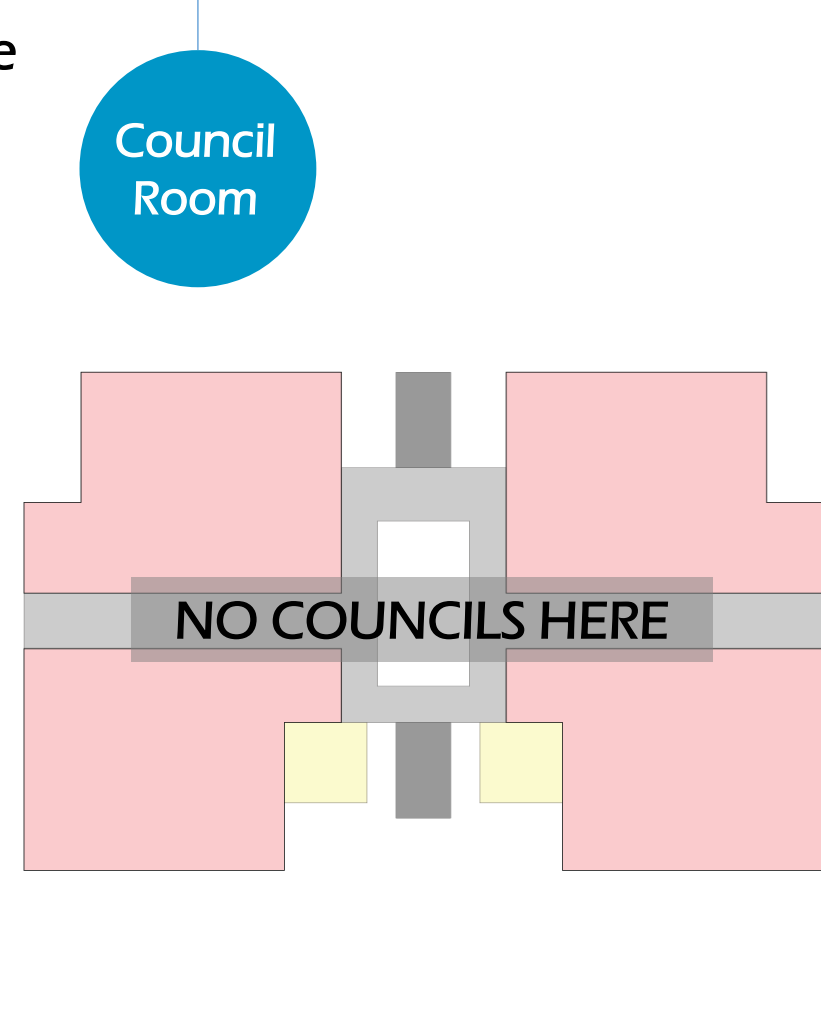

1ST FLOOR

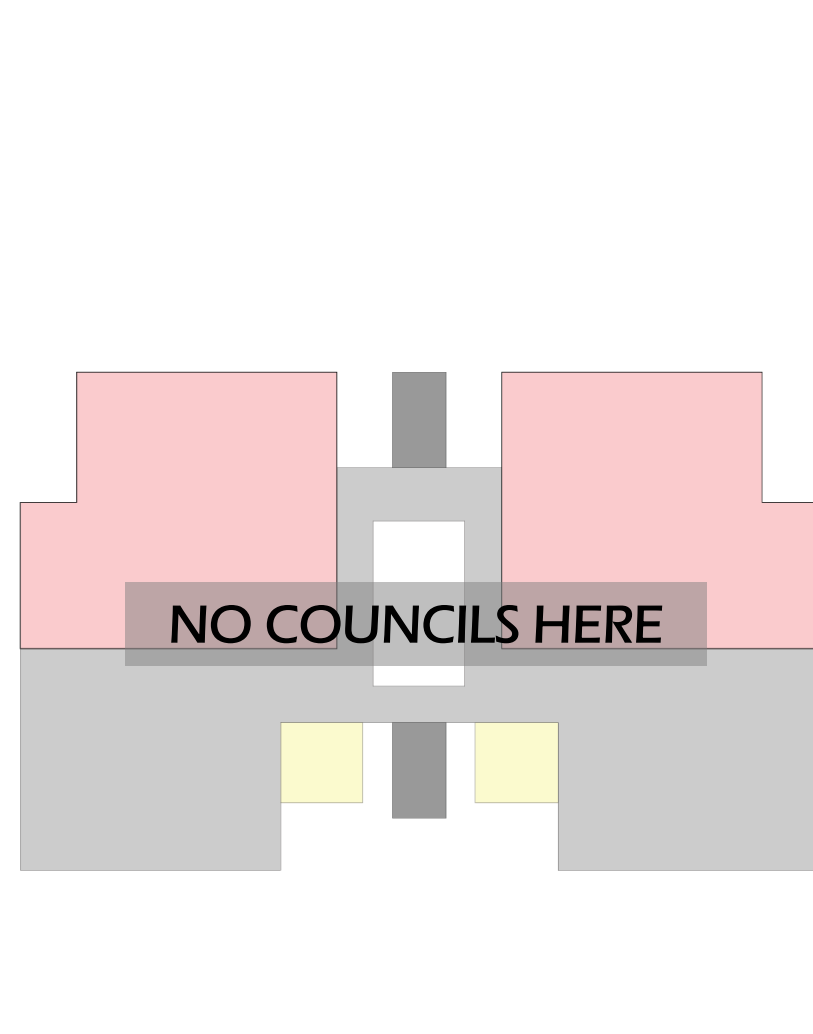

2ND FLOOR

LABORATORY BLOCK A

